

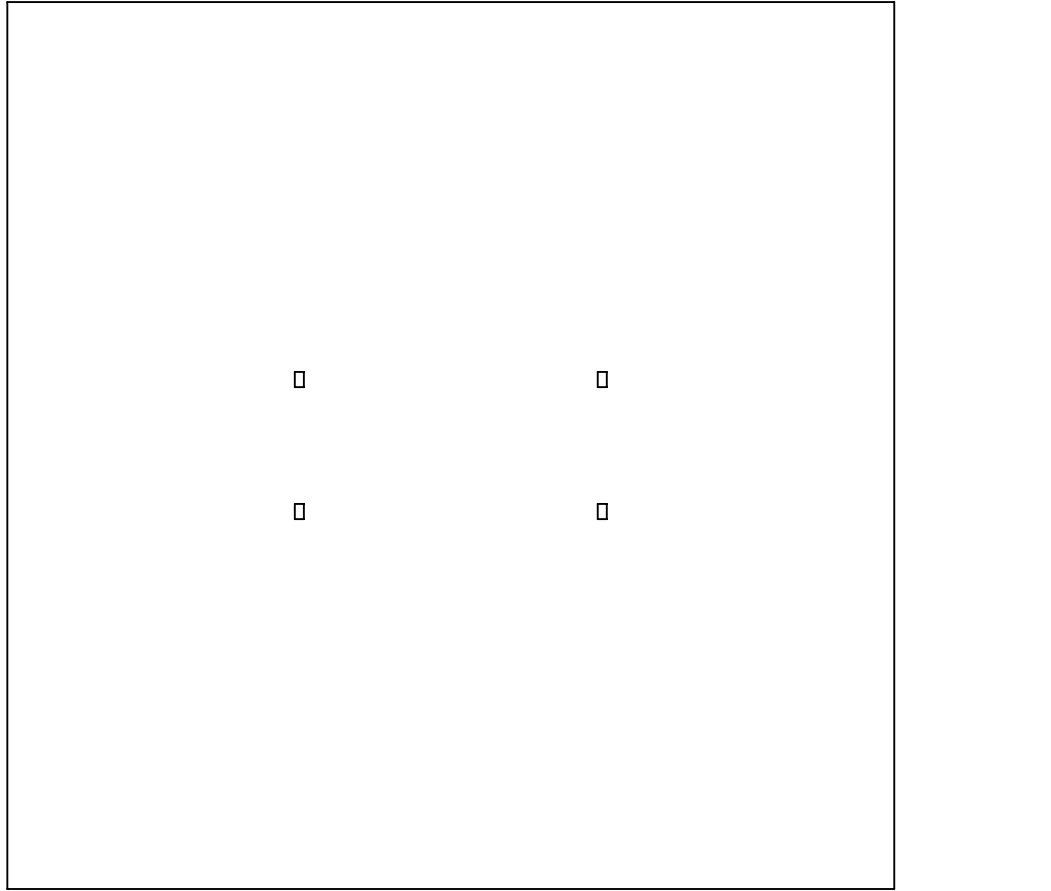

 BC CANCER GENOME SCIENCES CENTRE INSTRUMENTATION GROUP 604-707-5900 EXT 675465	DESCRIPTION:		FILE NUMBER:	
	Mounted Illumina Flowcell		1	
THIRD ANGLE PROJECTION 	DIMENSIONS IN MM		DRAWN BY:	
TOLERANCES XX +/- 2 XX.X +/- 0.5 XX.XX +/- 0.1 ANGULAR +/- 1°		PROJECT:		DATE:
MATERIAL STOCK NOTE:		Framed Flowcells		04/11/2019
FINISH:		NOTES:		QUANTITY: 24 SCALE: 1:1.5 SHEET SIZE: A SHEET: 1 OF 10





 <b>BC CANCER GENOME SCIENCES CENTRE</b> INSTRUMENTATION GROUP 604-707-5900 EXT 675465	DESCRIPTION:		FILE NUMBER:	
	Illumina Backing Card		DRAWN BY: ROBIN COOPE	
THIRD ANGLE PROJECTION 	DIMENSIONS IN MM		PROJECT:	DATE:
	Framing Cardstock		Framed Flowcells	04/11/2019
TOLERANCES		MATERIAL STOCK NOTE:	NOTES:	
XX	+/- 2	Framing Cardstock		
XX.X	+/- 0.5	FINISH:	QUANTITY	SCALE
XX.XX	+/- 0.1	PLAIN		1:1.5
ANGULAR	+/- 1°		SHEET SIZE	SHEET
			A	2 OF 10

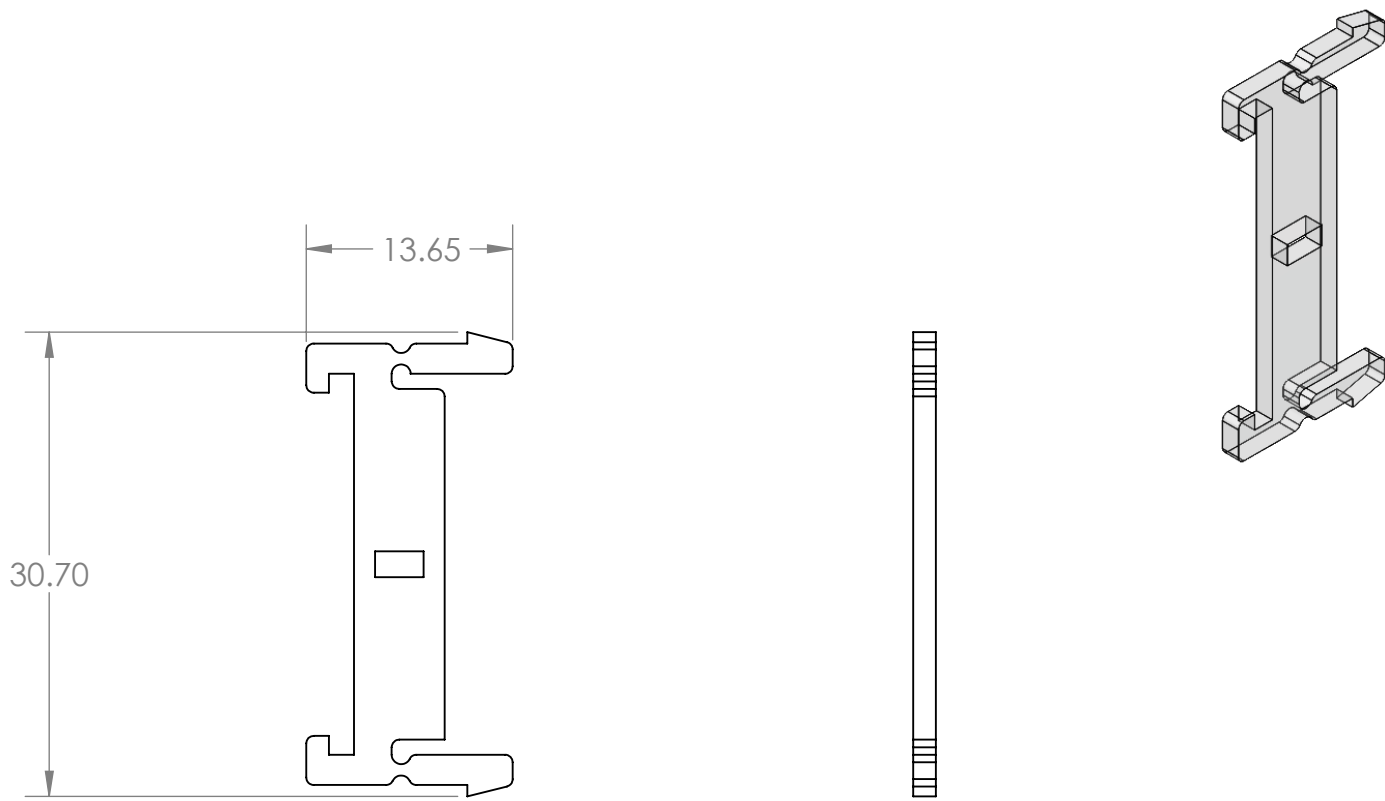

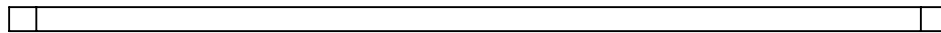

 <b>BC CANCER GENOME SCIENCES CENTRE</b> INSTRUMENTATION GROUP 604-707-5900 EXT 675465	DESCRIPTION: <b>Illumina Flowcell Clip</b>		FILE NUMBER:	
	PROJECT: <b>Framed Flowcells</b>		DRAWN BY: <b>ROBIN COOPE</b>	
THIRD ANGLE PROJECTION 	DIMENSIONS IN MM	NOTES:		DATE: <b>04/11/2019</b>
<b>TOLERANCES</b> XX +/- 2 XX.X +/- 0.5 XX.XX +/- 0.1 ANGULAR +/- 1°	MATERIAL STOCK NOTE: 1/16" Nominal Acrylic  FINISH: PLAIN Laser Cut	QUANTITY <b>1</b>		SCALE <b>2:1</b>
		SHEET SIZE <b>A</b>		SHEET <b>3 OF 10</b>



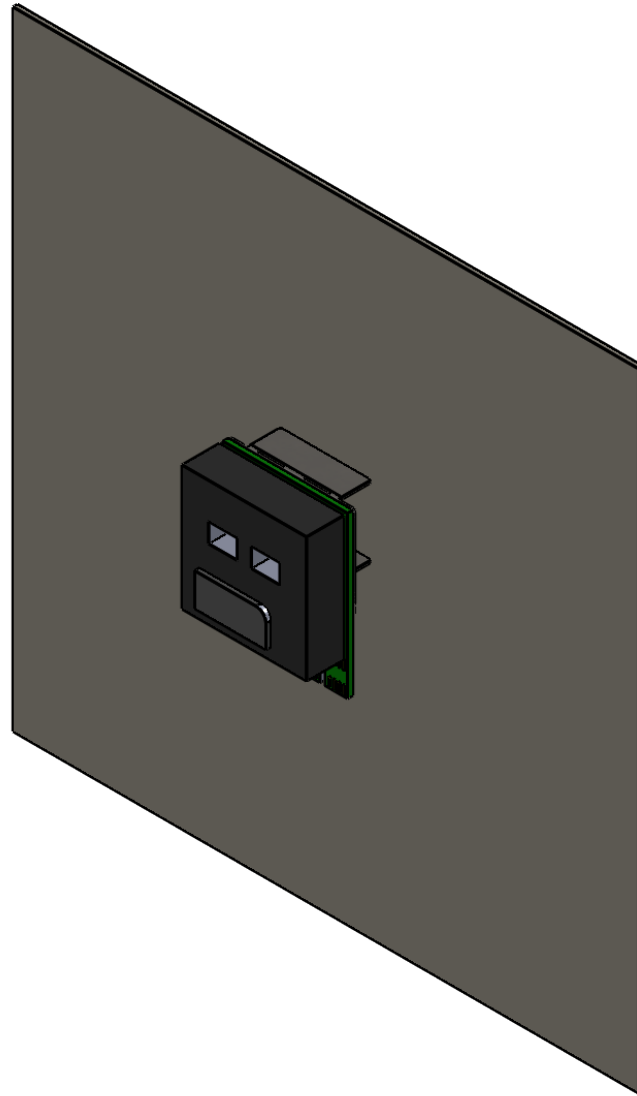

 <b>BC CANCER GENOME SCIENCES CENTRE</b> INSTRUMENTATION GROUP 604-707-5900 EXT 675465	DESCRIPTION: <b>Illumina Clip Crossbar</b>		FILE NUMBER:	
	PROJECT: <b>Framed Flowcells</b>		DRAWN BY: <b>ROBIN COOPE</b>	
THIRD ANGLE PROJECTION 	DIMENSIONS IN MM	DATE: <b>04/11/2019</b>		QUANTITY
<b>TOLERANCES</b> XX +/- 2 XX.X +/- 0.5 XX.XX +/- 0.1 ANGULAR +/- 1°	MATERIAL STOCK NOTE: 1/16 Acrylic  FINISH: PLAIN Laser Cut	NOTES:		SCALE <b>2:1</b>
			SHEET SIZE <b>A</b>	SHEET <b>4 OF 10</b>



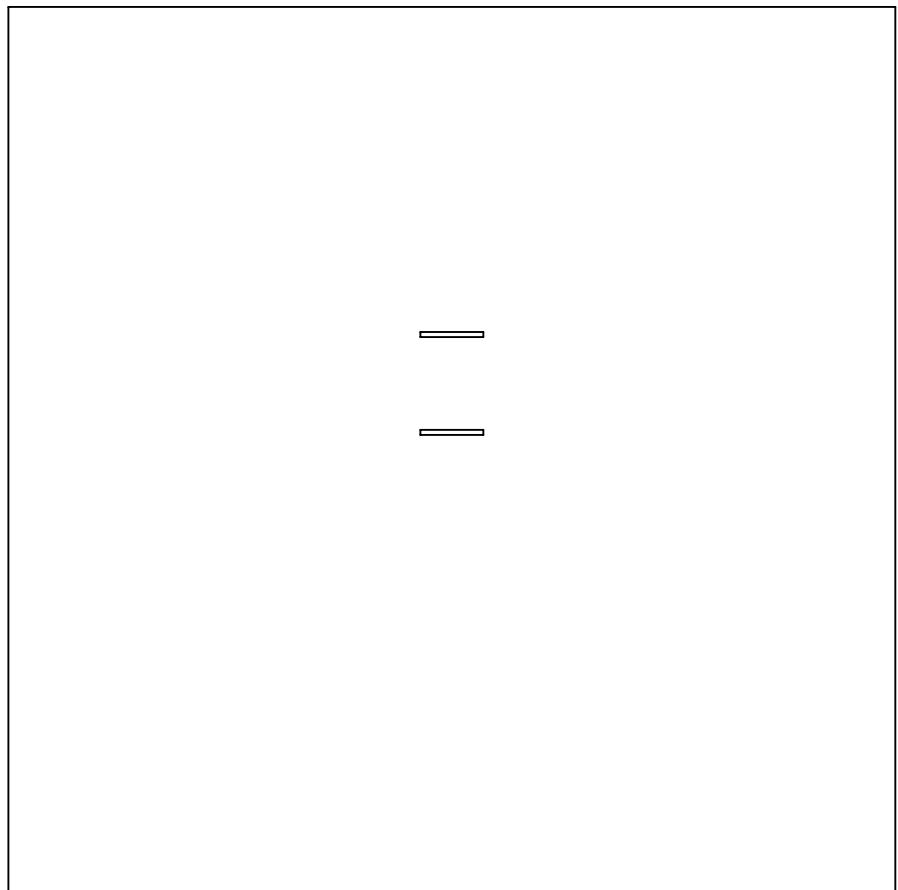

 BC CANCER GENOME SCIENCES CENTRE INSTRUMENTATION GROUP 604-707-5900 EXT 675465	DESCRIPTION: Mounted PromethION		FILE NUMBER: 1	
	PROJECT: Framed Flowcells		DRAWN BY: Robin Coope	
THIRD ANGLE PROJECTION 	DIMENSIONS IN MM	DATE: 04/11/2019		
<b>TOLERANCES</b> XX                    +/- 2 XX.X                +/- 0.5 XX.XX              +/- 0.1 ANGULAR           +/- 1°	MATERIAL STOCK NOTE: FINISH:	NOTES:		QUANTITY        SCALE 12                    1:1.5
				SHEET SIZE        SHEET <b>A</b> 5 OF 10



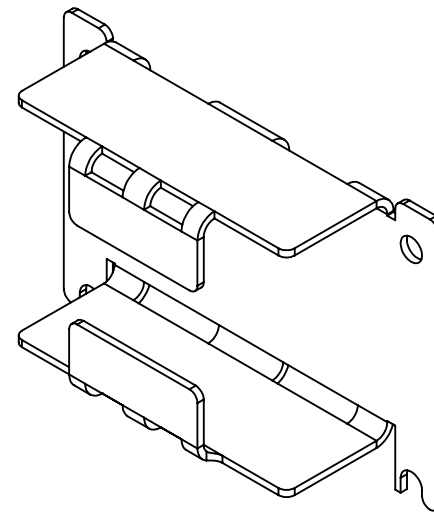
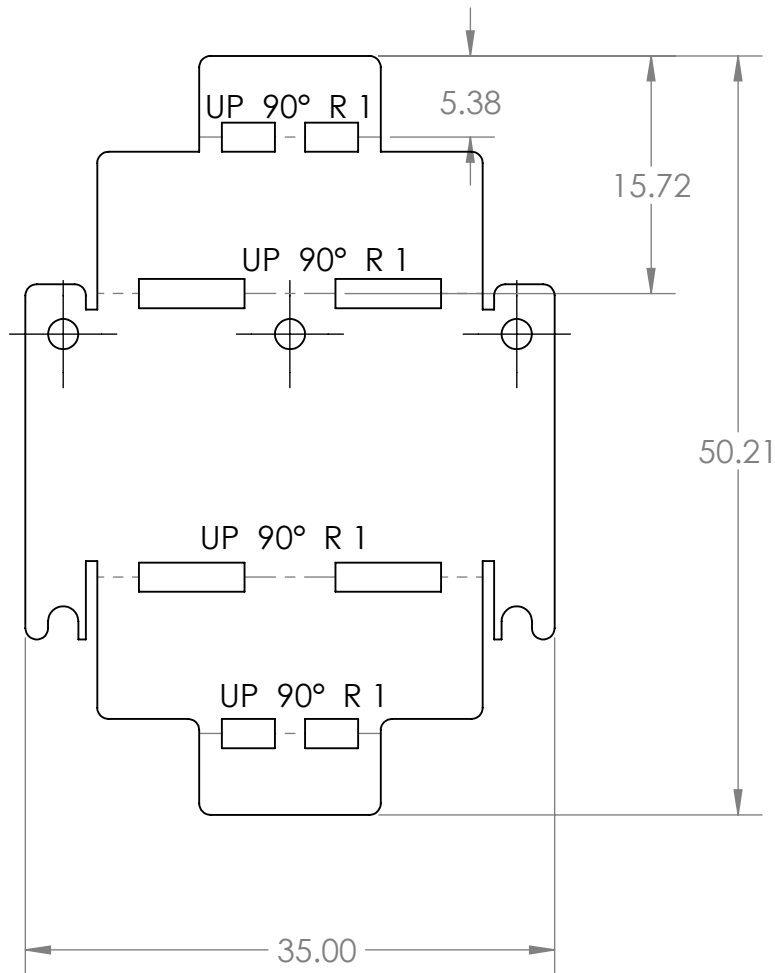

 <b>BC CANCER GENOME SCIENCES CENTRE</b> INSTRUMENTATION GROUP 604-707-5900 EXT 675465	DESCRIPTION: <b>Promethion Backing Card</b>		FILE NUMBER:	
	PROJECT: <b>Framed Flowcells</b>		DRAWN BY: <b>ROBIN COOPE</b>	
THIRD ANGLE PROJECTION 	DIMENSIONS IN MM	NOTES:		DATE: <b>04/11/2019</b>
<b>TOLERANCES</b> XX +/- 2 XX.X +/- 0.5 XX.XX +/- 0.1 ANGULAR +/- 1°	MATERIAL STOCK NOTE: <b>Framing Card</b>  FINISH: <b>PLAIN</b>	QUANTITY <b>A</b>		SCALE <b>1:1.5</b>
		SHEET SIZE <b>A</b>		SHEET <b>6 OF 10</b>



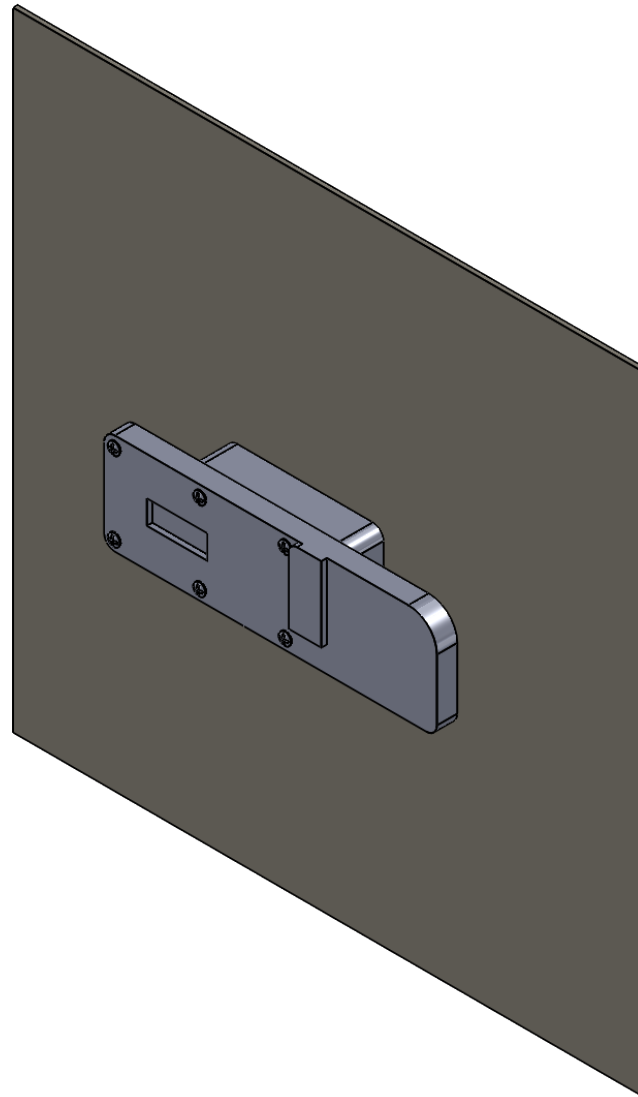

 BC CANCER GENOME SCIENCES CENTRE INSTRUMENTATION GROUP 604-707-5900 EXT 675465	DESCRIPTION: Promethion Clip		FILE NUMBER:	
	PROJECT: Framed Flowcells		DRAWN BY: ROBIN COOPE	
THIRD ANGLE PROJECTION 	DIMENSIONS IN MM		DATE: 04/11/2019	
TOLERANCES XX +/- 2 XX.X +/- 0.5 XX.XX +/- 0.1 ANGULAR +/- 1°	MATERIAL STOCK NOTE: 24Ga 304SS FINISH: PLAIN		QUANTITY SCALE 2:1	
			SHEET SIZE A	
			SHEET 7 OF 10	



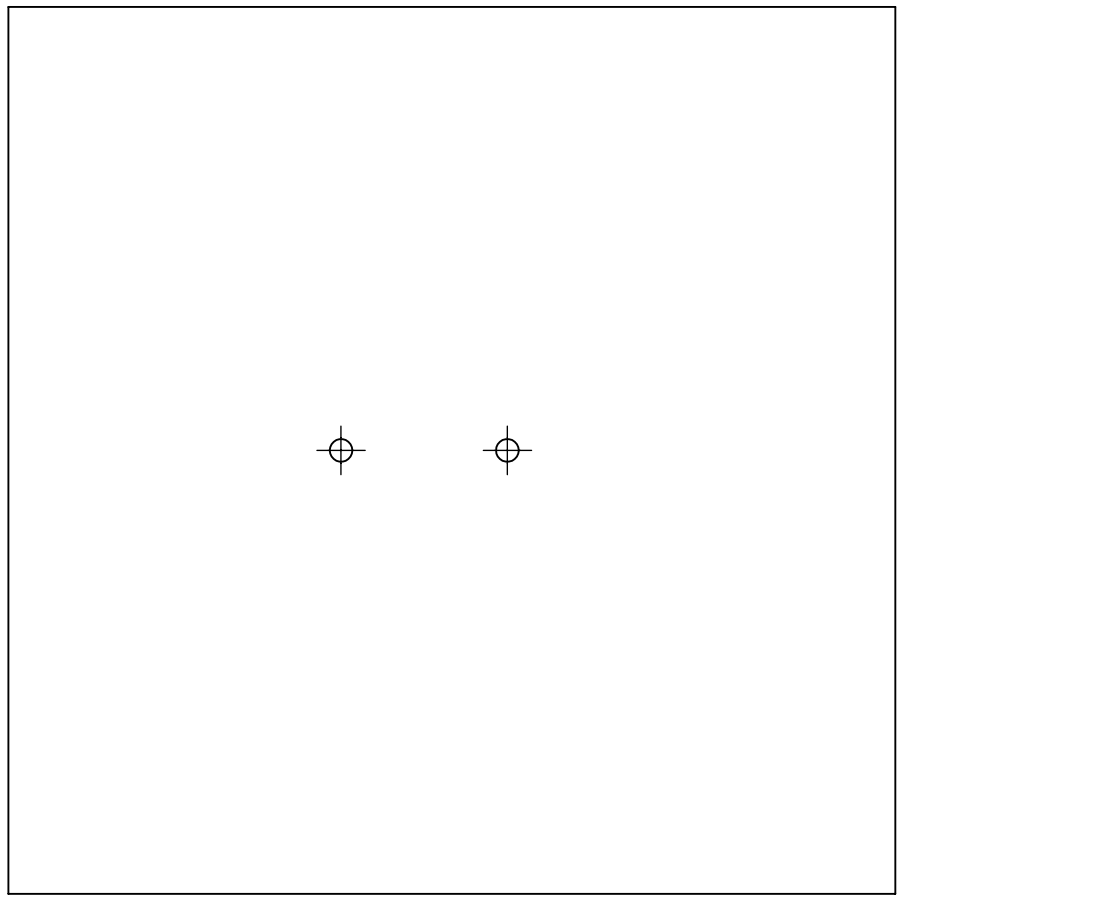

 BC CANCER GENOME SCIENCES CENTRE INSTRUMENTATION GROUP 604-707-5900 EXT 675465	DESCRIPTION:		FILE NUMBER:	
	Mounted MinION Flowcell		1	
THIRD ANGLE PROJECTION 	DIMENSIONS IN MM		PROJECT:	DATE:
TOLERANCES		Framed Flowcells		04/11/2019
XX +/- 2	MATERIAL STOCK NOTE:		QUANTITY	SCALE
XX.X +/- 0.5	FINISH:		12	1:1.5
XX.XX +/- 0.1			SHEET SIZE	SHEET
ANGULAR +/- 1°			A	8 OF 10



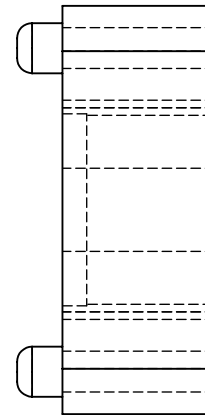
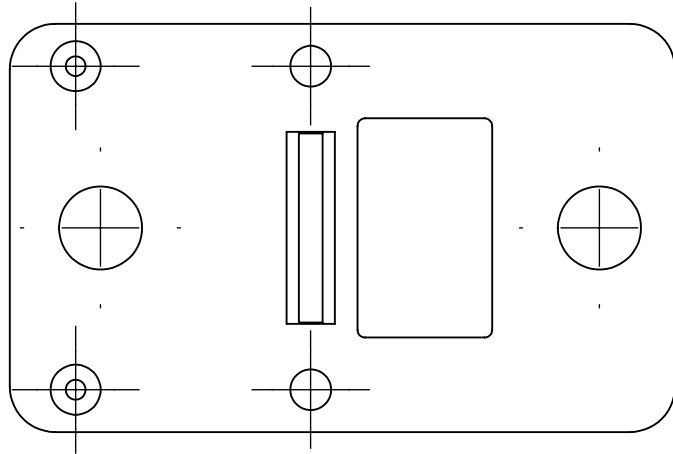
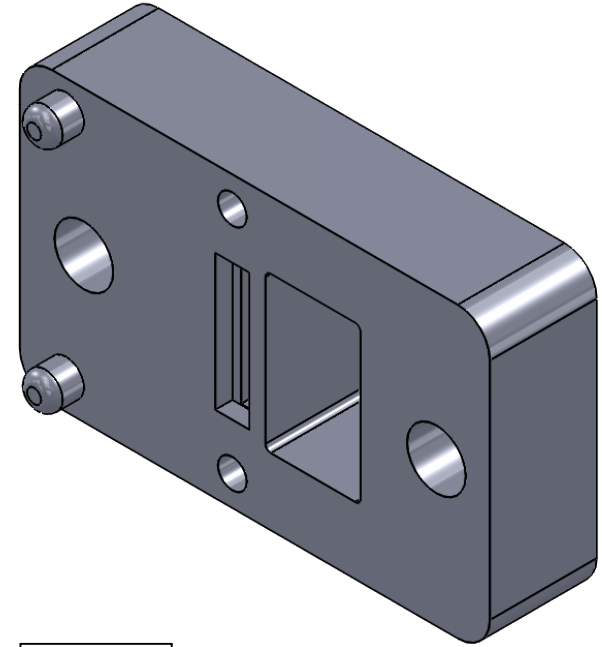
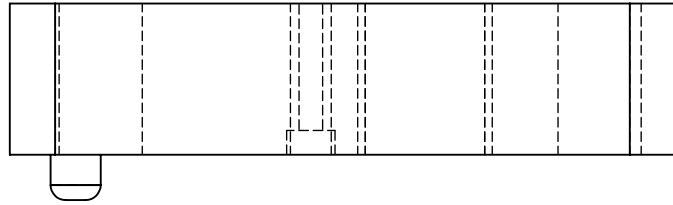

 <b>BC CANCER GENOME SCIENCES CENTRE</b> <b>INSTRUMENTATION GROUP</b> 604-707-5900 EXT 675465	<b>DESCRIPTION:</b> Minion Backing Card		<b>FILE NUMBER:</b>	
	<b>PROJECT:</b> Framed Flowcells		<b>DRAWN BY:</b> ROBIN COOPE	
<b>THIRD ANGLE PROJECTION</b> 	<b>DIMENSIONS IN MM</b>	<b>DATE:</b> 04/11/2019		<b>QUANTITY</b>
<b>TOLERANCES</b> XX +/- 2 XX.X +/- 0.5 XX.XX +/- 0.1 ANGULAR +/- 1°	<b>MATERIAL STOCK NOTE:</b> Framing Card	<b>NOTES:</b>		<b>SCALE</b> 1:1.5
	<b>FINISH:</b> PLAIN			<b>SHEET SIZE</b> <b>A</b>
				<b>SHEET</b> 9 OF 10



 <b>BC CANCER GENOME SCIENCES CENTRE</b> INSTRUMENTATION GROUP 604-707-5900 EXT 675465	DESCRIPTION: <p style="text-align: center;">MinION Mount</p>		FILE NUMBER:	
	DIMENSIONS IN MM		DRAWN BY: <p style="text-align: center;">ROBIN COOPE</p>	
THIRD ANGLE PROJECTION 	MATERIAL STOCK NOTE: <p style="text-align: center;">3D Printed</p>		PROJECT: <p style="text-align: center;">Framed Flowcells</p>	
<b>TOLERANCES</b> XX            +/- 2 XX.X        +/- 0.5 XX.XX      +/- 0.1 ANGULAR    +/- 1°	FINISH: <p style="text-align: center;">PLAIN</p>		DATE: <p style="text-align: center;">04/11/2019</p>	
			QUANTITY <p style="text-align: center;">12</p>	SCALE <p style="text-align: center;">2:1</p>
			SHEET SIZE <p style="text-align: center;">A</p>	SHEET <p style="text-align: center;">10 OF 10</p>